

SMD Magnetic Transducer

SFM-9027G03

Rev.2



FEATURES:

- Low Frequency
- Low Voltage
- Small and slim size

APPLICATIONS:

- Automatic Control Equipment
- Communication Equipment
- Electronic Instruments

DIMENSIONS: (Unit: mm)

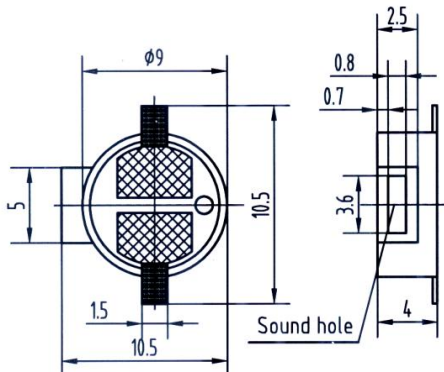

CHARACTERISTICS:

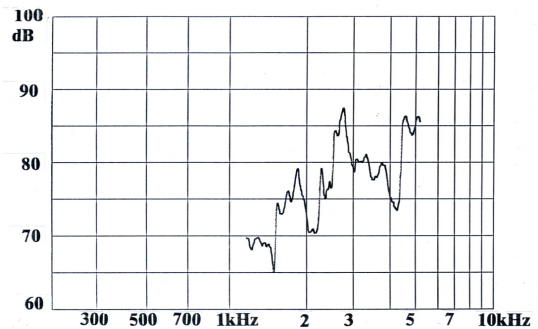

ELECTRICAL SPECIFICATIONS:

Min. Sound Pressure Level at 2730Hz/3V Square Wave/10cm.....	85dB(Typ.90)
Rated Voltage.....	3V
Operating Voltage.....	2~4V
Max. Consumption at 2730Hz/6Vp-p Square Wave.....	80mA/3V _{DC}
Resonant Frequency.....	2730Hz
Coil Resistance.....	16±3Ω
Storage Temperature.....	-40~+85°C
Operating Temperature.....	-40~+85°C
Housing Material.....	LCP
Weight.....	0.7g

TEST CIRCUITS:

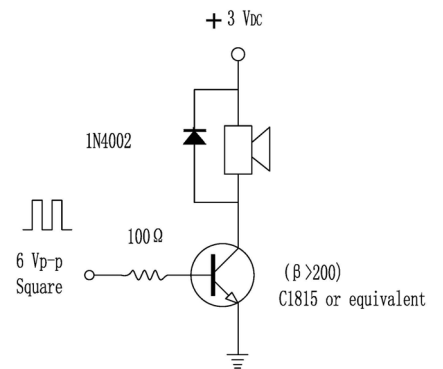

PACKING INFORMATION:

Packing: 2000 pcs per export carton
 Carton Size: 35×26×26 cm
 G. Weight: 2.4 kgs N. Weight: 2.0 kgs
 Address: No. 12. Lane 722. Sangtian Road Jiangdong, Ningbo, 315040 P. R. China
 Sales Tel: +86-574-87809820(International)/87805605(Domestic)
 Fax: +86-574-87803761

