

Thick Film Flat Array Chip Resistor—CN-21 & CN-41

Construction

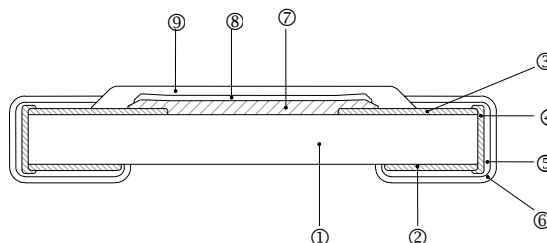

① Alumina Substrate	④ Edge Electrode (NiCr)	⑦ Resistor Layer (RuO ₂ /Ag)
② Bottom Electrode (Ag)	⑤ Barrier Layer (Ni)	⑧ Primary Overcoat (Glass)
③ Top Electrode (Ag-Pd)	⑥ External Electrode (Sn)	⑨ Secondary Overcoat (Epoxy)

Features

- Contribute to higher-density mounting and reduction in size of devices by remarkably PCB
- Contribute to the size reduction of small electronic equipment such as Mobile phone, HDD
- Reduced the mounting time by decreasing the number of components
- Suitable for IR reflow soldering

Part Numbering

CN-	41	J	L	6	---1K
Product Type	Dimensions 21: 0201x2 41: 0201x4	Resistance Tolerance J: ±5%	Function Code L: 8P4R / 4P2R	Packaging Code 6: 7" Reel 10Kpcs F: Bulk	Resistance ---1K: 1KΩ ---3K3: 3.3KΩ ---10K: 10KΩ *-* to fill up 6 spaces

Applications

- Pull-up/pull-down resistors for digital circuits
- Used in interface circuits of LCD displays, memory modules, etc.
- Communication Equipments

Derating Curve

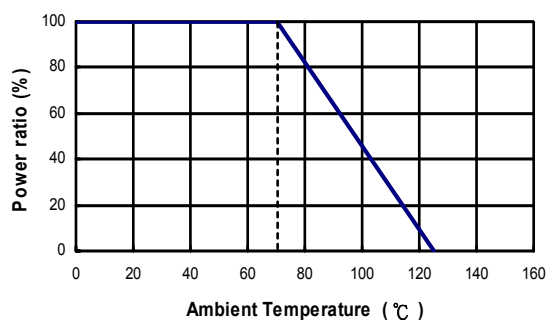

Dimensions

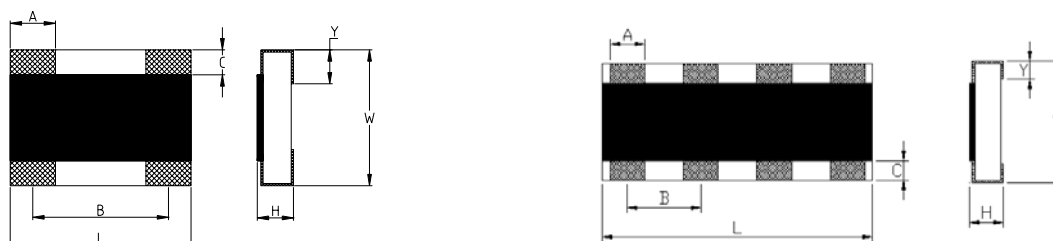

Unit: mm

Type	Number of Resistors	L	W	H	A	B	C	Y	Weight (g) (1000pcs)
CN-21	2	0.80±0.10	0.60±0.10	0.35±0.10	0.30±0.10	0.50±0.10	0.15±0.10	0.15±0.10	0.500
CN-41	4	1.40±0.10	0.60±0.10	0.35±0.10	0.20±0.10	0.40±0.1	0.10±0.07	0.15±0.05	0.833

Standard Electrical Specifications

Item Type	Power Rating / Rated Current	Operating Temp. Range	Max. Operating Voltage	Max. Overload Voltage	Number of Resistors	Resistance Range	TCR (PPM/°C)
						±5%	
CN-21	1/32W	-55 ~ +125°C	12.5V	25V	2	10Ω - 1MΩ	±200
Jumper	0.5A					0Ω (<50mΩ)	
CN-41	1/32W	-55 ~ +125°C	12.5V	25V	4	10Ω - 1MΩ	±200
Jumper	0.5A					0Ω (<50mΩ)	

Operating Voltage= $\sqrt{P \cdot R}$ or Max. operating voltage Listed above, whichever is lower.

Overload Voltage= $2.5 \cdot \sqrt{P \cdot R}$ or Max. overload voltage Listed above, whichever is lower.

■ Viking is capable of manufacturing the optional spec based on customer's requirement.

Environmental Characteristics

Item	Requirement		Test Method
	±5%	Jumper	
Temperature Coefficient of Resistance (T.C.R.)	As Spec.		-55°C~+125°C, 25°C is the reference temperature
Short Time Overload	±(2.0%+0.1Ω)	<50mΩ	2.5 times RCWV or Max. overload voltage for 5 seconds
Insulation Resistance	≥ 10G		Max. overload voltage for 1 minute
Endurance	±(3.0%+0.1Ω)	<100mΩ	70±2°C, Max. working voltage for 1000 hrs with 1.5 hrs "ON" and 0.5 hrs "OFF"
Damp Heat with Load	±(3.0%+0.1Ω)	<50mΩ	40±2°C, 90~95% R.H., Max. working voltage for 1000 hrs with 1.5 hrs "ON" and 0.5 hrs "OFF"
Dry Heat	±(3.0%+0.1Ω)	<100mΩ	at +125°C for 1000 hrs
Bending Strength	±(1.0%+0.05Ω)	<50mΩ	Bending once for 5 seconds with 3mm
Solderability	95% min. coverage		245±5°C for 3 seconds
Resistance to Soldering Heat	±(1.0%+0.05Ω)	<50mΩ	260±5°C for 10 seconds
Voltage Proof	No breakdown or flashover		1.42 times RCWV (RMS) for 1 minute
Rapid Change of Temperature	±(1.0%+0.05Ω)	<50mΩ	-55°C to +125°C, 5 cycles

■ Reference Standards: IEC 60115-1, 60068-2-58; JIS-C 5201-1

■ Storage Temperature: 25±3°C; Humidity < 80%RH

Equivalent Circuit Diagram

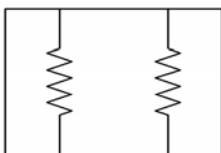

CN-21

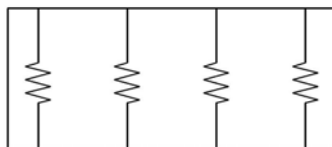

CN-41

Packaging

Reel Specifications & Packaging Quantity

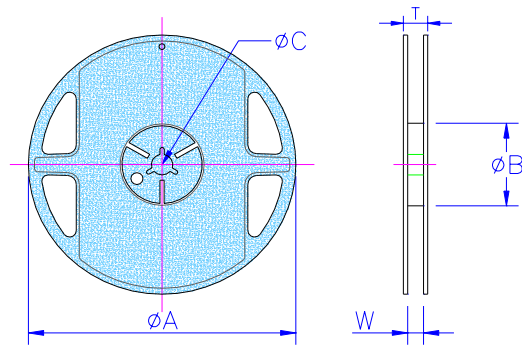

Unit: mm

Type	Packaging Quantity	Tape Width	Reel Diameter	ΦA	ΦB	ΦC	W	T	
CN-21	Paper	10K	8mm	7 inch	178.5±1.5	60 ^{+1/-0}	13.0±0.2	9.0±0.5	12.5±0.5
CN-41	Paper	10K	8mm	7 inch	178.5±1.5	60 ^{+1/-0}	13.0±0.2	9.0±0.5	12.5±0.5

Paper Tape Specifications

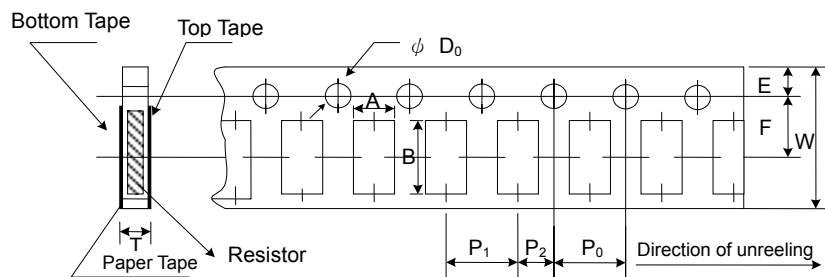

Unit: mm

Type	A	B	W	E	F	P ₀	P ₁	P ₂	ΦD ₀	T
CN-21	0.77±0.05	0.97±0.05	8.00±0.20	1.75±0.10	3.50±0.05	4.00±0.10	2.00±0.05	2.00±0.05	1.5 ^{+0.1/-0}	0.50±0.10
CN-41	0.77±0.05	1.57±0.05	8.00±0.20	1.75±0.10	3.50±0.05	4.00±0.10	2.00±0.05	2.00±0.05	1.5 ^{+0.1/-0}	0.50±0.10

Recommend Land Pattern

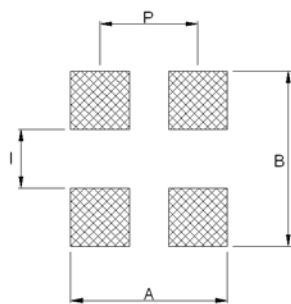

CN-21

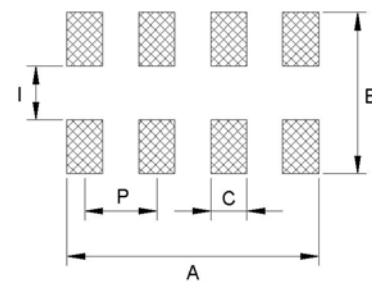

CN-41

Unit : mm

Type	A	B	C	I	P
CN-21	0.80	0.90	--	0.30	0.50
CN-41	1.40	0.90	0.20	0.30	0.40