

Glass/ET Series Caps

Elevated Temperature



HEAT

It's the enemy of reliable, long-term circuit performance. In many applications, very high temperatures are not a consideration in circuit design. But in a few specialized areas, elevated temperatures create very real design problems.

That's why AVX ET-Series capacitors keep working at temperatures where more ordinary capacitors usually fail...up to 200°C.

And, of course, AVX ET-Series capacitors provide all the high performance,

high reliability characteristics you've come to expect from all AVX glass capacitors...excellent stability, outstanding capacitance retraceability, rugged, simple construction to eliminate mechanical problems, and electrical performance specifications among the best available at any price.

So when the heat's on your next design and you can't alter the environment, choose AVX ET-Series glass capacitors. That'll be one less problem you'll have to solve.

FEATURES

- Available in both axial and radial leaded configurations
- Values from 0.5 pF to 2400 pF
- Working temperature range -75°C to 200°C
- "Burned In" versions available – 50 hours @ 1500 VDC, 25°C
- Simple, rugged design and construction
- Short lead times for most values

STANDARD OPERATING CHARACTERISTICS OF AVX ET-SERIES AXIAL AND RADIAL LEADED GLASS CAPACITORS

Working Temperature Range	-75°C to 200°C
Voltage Rating	50 VDC
Capacitance Range	0.5 pF to 2400 pF
Insulation Resistance	@ 25°C > 100,000 Megohms @ 200°C > 100 Megohms
Dissipation Factor	@ 25°C < .1% at 1kHz @ 200°C < 1% at 1kHz
Life	(1000 hours at rated voltage at 200°C) Post Test Delta C @ 25°C < 2% DF @ 25°C < 2.5% IR > 100 Megohms (axials) IR > 10 Megohms (radials)
Short Time (1 Hour) Exposure to Overtemperature (250°C)	No degradation
Voltage Coefficient	0

TYPICAL APPLICATIONS

In general, AVX ET-Series glass capacitors are ideally suited for any environment where high temperature could alter or destroy circuit performance. And since they are rated down to -75°C, ET-Series capacitors are also useful where cycling to colder temperatures may be a problem. Some applications where AVX ET-Series capacitors have already proven themselves include:

- Oil, well logging and downhole instrumentation, where frictional or geothermal heat is a problem.
- Geophysical pressure probes.
- Missile or aerospace applications where engine or environmental heat needs to be monitored or may cause circuit failure.
- Radar or other microwave applications.
- RF output circuitry where conduction or fan cooling cannot be entirely relied upon to remove all of the heat.
- Space and satellite applications where temperature changes are extreme and "zero failures" are a must.
- Industrial chemical process instrumentation where heat is a part of the process.
- Instrumentation for monitoring at-the-tool performance in metal cutting machinery.
- Fire-safe alarm or control circuitry.

Glass/ET Series Caps

Performance Curves

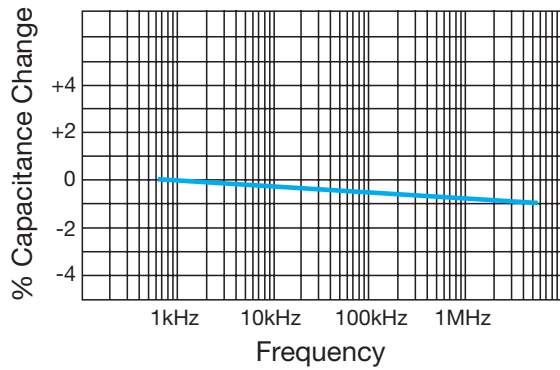

**% Capacitance Change vs. Frequency
Radial and Axial**

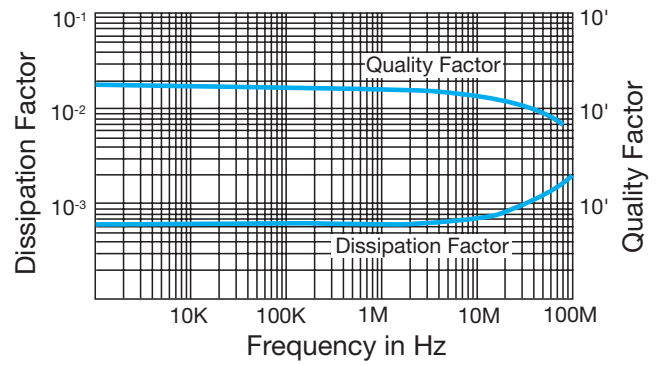

**Quality Factor and Dissipation Factor vs. Frequency
Radial**

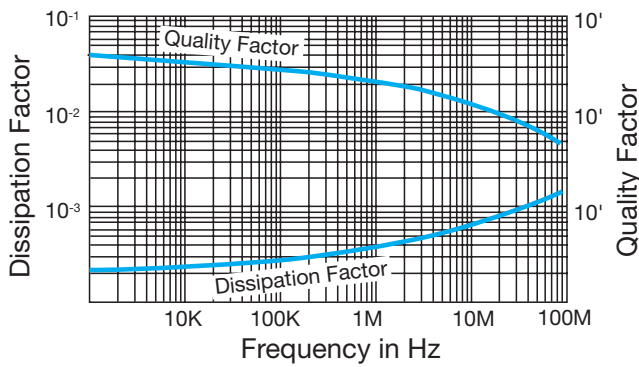

**Quality Factor and Dissipation Factor vs. Frequency
Axial**

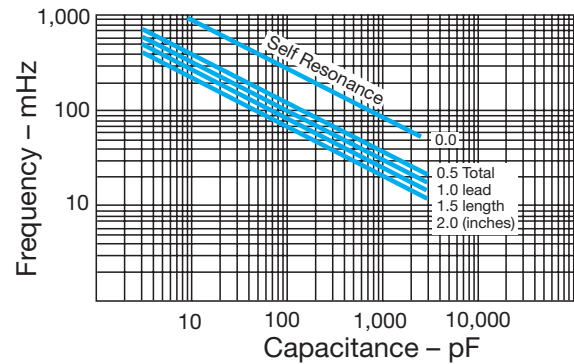

**Resonant Frequency vs. Capacitance
Radial**

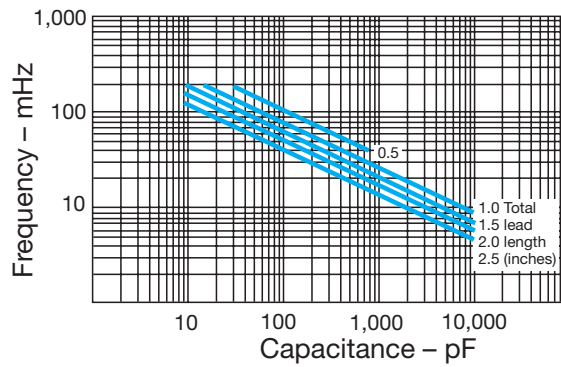

**Resonant Frequency vs. Capacitance
Axial**



Glass/ET Series Caps

Axial Lead Elevated Temperature



INTRODUCTION

AVX ET-Series axial leaded glass capacitors* are available in two standard case sizes and in a wide range of values and tolerances. All feature extremely stable glass dielectric, fused monolithic construction and true glass-to-metal hermetic seals at the leads for moisture resistance. All case sizes conform to industry dimensional standards.

PERFORMANCE CHARACTERISTICS

Tolerance: Available tolerances for each capacitance value are shown in the ordering information table on following page. Part marking codes are also provided.

Temperature Coefficient: Capacitance exhibits retraceability to within 10 ppm/°C over the temperature range -75°C to +200°C. See graph on following page.

Voltage Coefficient: Zero

Losses: Extremely low over the entire specified operating temperature range. Dissipation factor is 1% or less at 200°C at 1kHz.

Life: Delta C is less than 2% after 1000 hours at rated voltage, 200°C.

Insulation Resistance: Greater than 100,000 megohms at 25°C; greater than 100 megohms at 200°C. More than 100 megohms after life-testing.

Voltage/Temperature Rating: All ET-Series capacitors are rated at 50 VDC over their operating temperature range of -75°C to 200°C. No derating is required.

High Voltage Stabilization Screening: A special version of ET-Series axial leaded capacitors – designated ETR – is available. These capacitors have been “burned in” at room temperature for 50 hours at 1500 VDC.

Short Time Overtemperature Exposure: After exposure to 250°C for one hour, ET-Series capacitors have continued to perform to specification.

Moisture Resistance: Axial glass capacitors are hermetically sealed in glass, with a true metal-to-glass seal at the leads. This construction provides practical immunity to environmental effects such as shock, moisture, salt spray and solder heat.

Additional performance details are given in the AVX “Performance Characteristics of Multilayer Glass Dielectric Capacitors” technical paper.

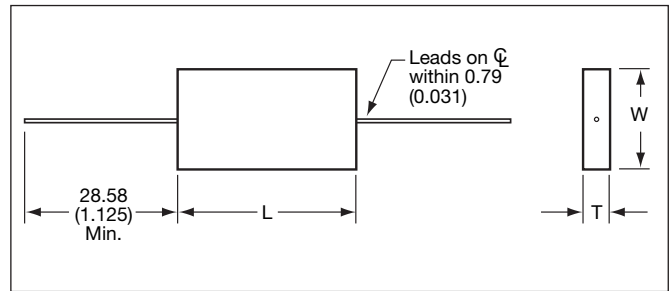
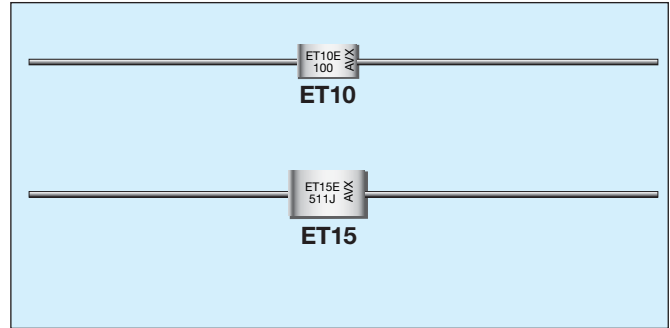

DIMENSIONS:

millimeters (inches)

Case Size	L	W	T	Lead Dia. +0.1 (+0.004) -0.03 (-0.001)	Weight (grams)
ET10	8.74 ± 1.19 (0.344 ± 0.047)	4.37 ± 0.79 (0.172 ± 0.031)	1.98 ± 0.79 (0.078 ± 0.031)	5.08 (0.200)	.25 - .50
ET15	11.91 ± 1.19 (0.469 ± 0.047)	6.76 ± 0.79 (0.266 ± 0.031)	2.77 ± 1.19 (0.109 ± 0.047)	5.08 (0.200)	.75 - 1.25

Note: Standard leads are solder-coated Dumet.

MARKING

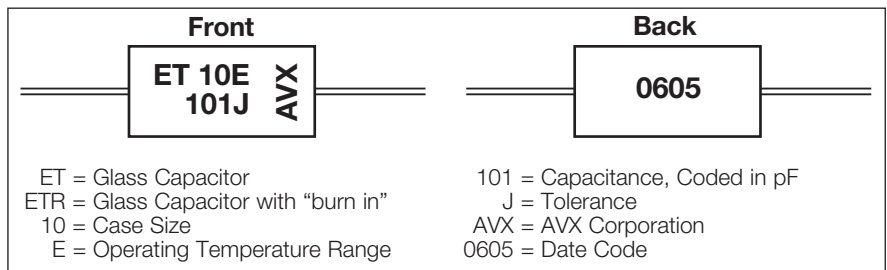

*Radiation Resistance to the same level as the CY, CYR axial series.



Glass/ET Series Caps

Part Numbers and Ordering Information



HOW TO ORDER

ET Style Glass Capacitor	10 Case Size 10 15	E Operating Temperature Range -75°C to +200°C	101 Capacitance Code Capacitance Code is expressed in picofarads (pF). The first two digits represent significant figures and the third digit specifies the number of zeros to follow; i.e. 101 indicates 100 pF. For values below 10 pF, R = decimal point; i.e. 1R5 indicates 1.5 pF.	J Capacitance Tolerance C = ±.25 pF D = ±.50 pF F = ±1% G = ±2% J = ±5% K = ±10% M = ±20%
--	---	--	---	---

RATINGS & PART NUMBER REFERENCE (Standard Values)

ET Part No.	ETR Part No.	Cap (pF)	Tolerances Available Voltage	DC Working
ET10, ETR10				
ET10E0R5 *	ETR10E0R5 **	0.5	C	50
ET10E1R0	ETR10E1R0	1.0	C, D	50
ET10E1R5	ETR10E1R5	1.5	C, D	50
ET10E2R2	ETR10E2R2	2.2	C, D	50
ET10E2R7	ETR10E2R7	2.7	C, D	50
ET10E3R0	ETR10E3R0	3.0	C, D	50
ET10E3R3	ETR10E3R3	3.3	C, D	50
ET10E3R6	ETR10E3R6	3.6	C, D	50
ET10E3R9	ETR10E3R9	3.9	C, D	50
ET10E4R3	ETR10E4R3	4.3	C, D	50
ET10E4R7	ETR10E4R7	4.7	C, K	50
ET10E5R1	ETR10E5R1	5.1	C, J, K	50
ET10E5R6	ETR10E5R6	5.6	C, J, K	50
ET10E6R2	ETR10E6R2	6.2	C, J, K	50
ET10E6R8	ETR10E6R8	6.8	C, J, K	50
ET10E7R5	ETR10E7R5	7.5	C, J, K	50
ET10E8R2	ETR10E8R2	8.2	C, J, K	50
ET10E9R1	ETR10E9R1	9.1	C, J, K	50
ET10E100	ETR10E100	10	C, J, K, M	50
ET10E110	ETR10E110	11	C, J, K, M	50
ET10E120	ETR10E120	12	C, J, K, M	50
ET10E130	ETR10E130	13	C, G, J, K, M	50
ET10E150	ETR10E150	15	C, G, J, K, M	50
ET10E160	ETR10E160	16	C, G, J, K, M	50
ET10E180	ETR10E180	18	C, G, J, K, M	50
ET10E200	ETR10E200	20	C, G, J, K, M	50
ET10E220	ETR10E220	22	C, G, J, K, M	50
ET10E240	ETR10E240	24	C, G, J, K, M	50
ET10E270	ETR10E270	27	F, G, J, K, M	50
ET10E300	ETR10E300	30	F, G, J, K, M	50
ET10E330	ETR10E330	33	F, G, J, K, M	50
ET10E360	ETR10E360	36	F, G, J, K, M	50
ET10E390	ETR10E390	39	F, G, J, K, M	50
ET10E430	ETR10E430	43	F, G, J, K, M	50
ET10E470	ETR10E470	47	F, G, J, K, M	50
ET10E510	ETR10E510	51	F, G, J, K, M	50
ET10E560	ETR10E560	56	F, G, J, K, M	50
ET10E620	ETR10E620	62	F, G, J, K, M	50
ET10E680	ETR10E680	68	F, G, J, K, M	50
ET10E750	ETR10E750	75	F, G, J, K, M	50

Add letter for tolerance code above lines.
These capacitors include a "burn in", see page 20 High Voltage Stabilization Screening.

ET Part No.	ETR Part No.	Cap (pF)	Tolerances Available Voltage	DC Working
ET10, ETR10 (cont'd)				
ET10E820	ETR10E820	82	F, G, J, K, M	50
ET10E910	ETR10E910	91	F, G, J, K, M	50
ET10E101	ETR10E101	100	F, G, J, K, M	50
ET10E111	ETR10E111	110	F, G, J, K, M	50
ET10E121	ETR10E121	120	F, G, J, K, M	50
ET10E131	ETR10E131	130	F, G, J, K, M	50
ET10E151	ETR10E151	150	F, G, J, K, M	50
ET10E161	ETR10E161	160	F, G, J, K, M	50
ET10E181	ETR10E181	180	F, G, J, K, M	50
ET10E201	ETR10E201	200	F, G, J, K, M	50
ET10E221	ETR10E221	220	F, G, J, K, M	50
ET10E241	ETR10E241	240	F, G, J, K, M	50
ET10E271	ETR10E271	270	F, G, J, K, M	50
ET10E301	ETR10E301	300	F, G, J, K, M	50
ET15, ETR15				
ET15E221	ETR15E221	220	F, G, J, K, M	50
ET15E241	ETR15E241	240	F, G, J, K, M	50
ET15E271	ETR15E271	270	F, G, J, K, M	50
ET15E301	ETR15E301	300	F, G, J, K, M	50
ET15E331	ETR15E331	330	F, G, J, K, M	50
ET15E361	ETR15E361	360	F, G, J, K, M	50
ET15E391	ETR15E391	390	F, G, J, K, M	50
ET15E431	ETR15E431	430	F, G, J, K, M	50
ET15E471	ETR15E471	470	F, G, J, K, M	50
ET15E511	ETR15E511	510	F, G, J, K, M	50
ET15E561	ETR15E561	560	F, G, J, K, M	50
ET15E621	ETR15E621	620	F, G, J, K, M	50
ET15E681	ETR15E681	680	F, G, J, K, M	50
ET15E751	ETR15E751	750	F, G, J, K, M	50
ET15E821	ETR15E821	820	F, G, J, K, M	50
ET15E911	ETR15E911	910	F, G, J, K, M	50
ET15E102	ETR15E102	1000	F, G, J, K, M	50
ET15E112	ETR15E112	1100	F, G, J, K, M	50
ET15E122	ETR15E122	1200	F, G, J, K, M	50

Add letter for tolerance code above lines.
These capacitors include a "burn in", see page 20 High Voltage Stabilization Screening.

Dissipation Factor vs. Temperature Axial

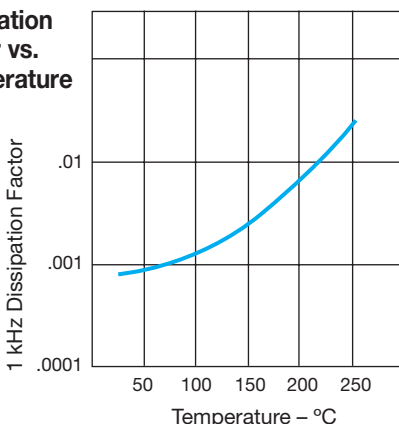

% Capacitance Change vs. Temperature Axial

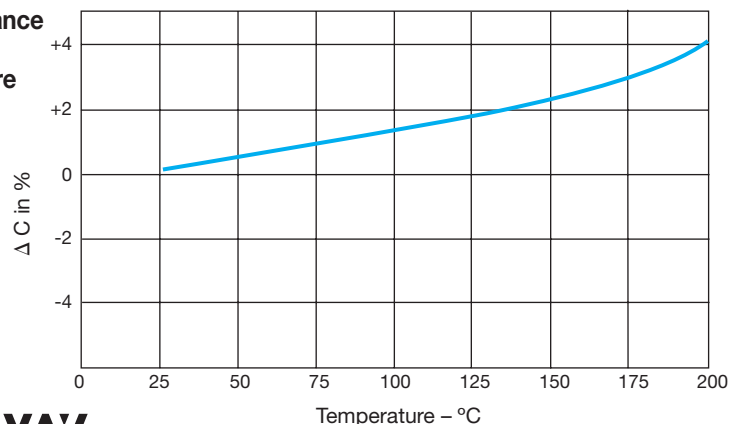

Glass/ET Series Caps

Radial Lead Elevated Temperature



INTRODUCTION

AVX ET-Series radial leaded glass capacitors are available in a broad range of tolerances and values in three case sizes. The fused monolithic capacitive element is housed in a miniature rectangular molded case for high packaging efficiency in circuit board applications. The gold-plated Dumet leads can be soldered or welded.

PERFORMANCE CHARACTERISTICS

Tolerance: The ordering information table on the opposite page gives the available tolerances and values. An explanation of the part marking code is also provided.

Temperature Coefficient: Capacitance exhibits retraceability to within 10 ppm/°C over the temperature range -75°C to 200°C. See graph on following page.

Voltage Coefficient: Zero

Losses: Over the specified temperature range, losses are very low. At 200°C, 1kHz, the dissipation factor is 1% or less.

Life: Delta C is less than 2% after 1000 hours at rated voltage, 200°C.

Insulation Resistance: 100,000 megohms or greater at 25°C; 100 megohms or greater at 200°C. More than 10 megohms after 1000 hour life-test.

Voltage/Temperature Rating: All ET-Series capacitors are rated at 50 VDC over the operating temperature range of -75°C to 200°C. Derating is not required.

High Voltage Stabilization Screening: A special version of ET-Series radial leaded capacitors – designated **ETR** – is available. These capacitors have been “burned in” at room temperature for 50 hours at 1500 VDC.

Short Time Overtemperature Exposure: After exposure to 250°C for one hour, ET-Series capacitors have continued to perform to specification.

Additional performance details are given in the AVX “Performance Characteristics of Multilayer Glass Dielectric Capacitors” technical paper.

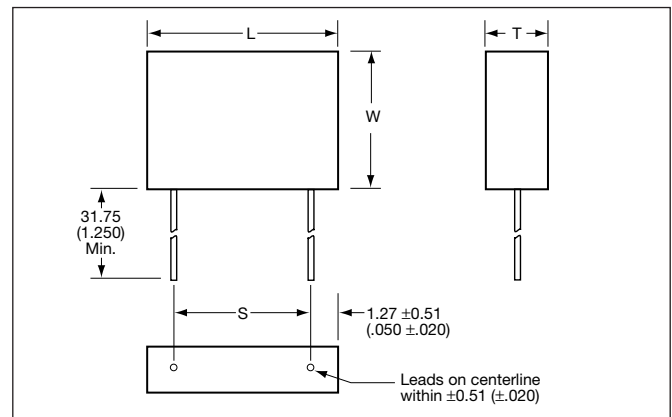
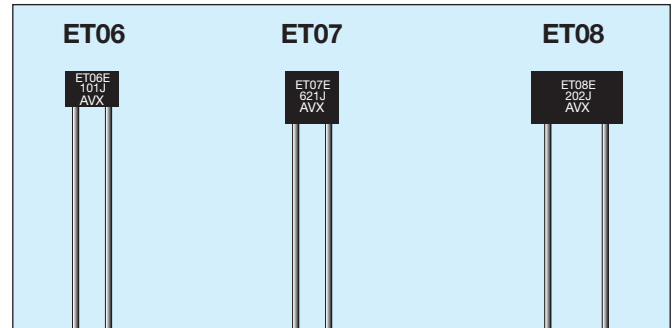

DIMENSIONS:

Case Size	millimeters (inches)				
	L ±0.13 (±0.005)	W ±0.25 (±0.010)	T ±0.13 (±0.005)	S +0.51 (±0.020)	Weight (grams)
ET06	7.62 (0.300)	5.08 (0.200)	2.92 (0.115)	5.08 (0.200)	.3 - .4
ET07	7.62 (0.300)	7.62 (0.300)	2.92 (0.115)	5.08 (0.200)	.4 - .5
ET08	12.7 (0.500)	7.62 (0.300)	2.92 (0.115)	10.16 (0.400)	.7 - .8

Note: All leads are 24 AWG, 0.51± 0.05 (0.020±0.002) diameter. Leads are solderable and welded gold-plated Dumet.

MARKING

AVX = AVX Corporation
 ET = Glass Capacitor
 ETR = Glass Capacitor with “burn in”
 06 = Case Size
 E = Operating Temperature Range
 561 = Capacitance, Coded in pF
 J = Tolerance
 0625 = Date Code

Glass/ET Series Caps

Part Numbers and Ordering Information



HOW TO ORDER

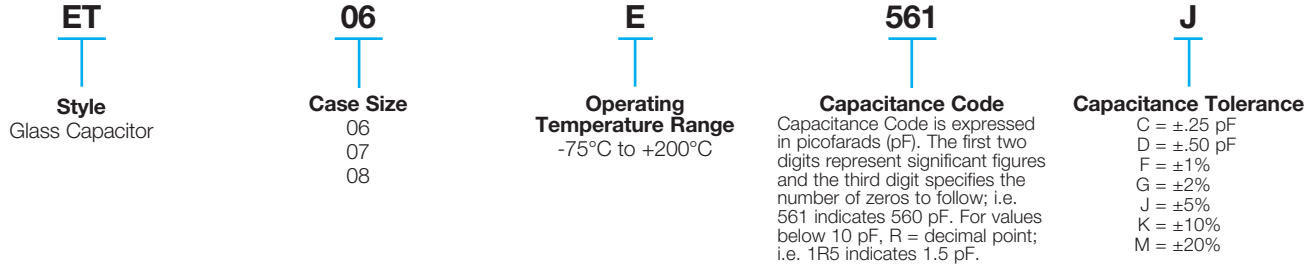

RATINGS & PART NUMBER REFERENCE (Standard Values)

ET Part No.	ETR Part No.	Cap (pF)	Tolerances Available Voltage	DC Working
ET06, ETR06				
ET06E1R0*	ETR06E1R0**	1.0	C, D	50
ET06E1R5	ETR06E1R5	1.5	C, D	50
ET06E2R2	ETR06E2R2	2.2	C, D	50
ET06E2R7	ETR06E2R7	2.7	C, D	50
ET06E3R0	ETR06E3R0	3.0	C, D	50
ET06E3R3	ETR06E3R3	3.3	C, D	50
ET06E3R6	ETR06E3R6	3.6	C, D	50
ET06E3R9	ETR06E3R9	3.9	C, D	50
ET06E4R3	ETR06E4R3	4.3	C, D	50
ET06E4R7	ETR06E4R7	4.7	C, K	50
ET06E5R1	ETR06E5R1	5.1	C, J, K	50
ET06E5R6	ETR06E5R6	5.6	C, J, K	50
ET06E6R2	ETR06E6R2	6.2	C, J, K	50
ET06E6R8	ETR06E6R8	6.8	C, J, K	50
ET06E7R5	ETR06E7R5	7.5	C, J, K	50
ET06E8R2	ETR06E8R2	8.2	C, J, K	50
ET06E9R1	ETR06E9R1	9.1	C, J, K	50
ET06E100	ETR06E100	10	C, J, K, M	50
ET06E110	ETR06E110	11	C, J, K, M	50
ET06E120	ETR06E120	12	C, J, K, M	50
ET06E130	ETR06E130	13	C, G, J, K, M	50
ET06E150	ETR06E150	15	C, G, J, K, M	50
ET06E160	ETR06E160	16	C, G, J, K, M	50
ET06E180	ETR06E180	18	C, G, J, K, M	50
ET06E200	ETR06E200	20	C, G, J, K, M	50
ET06E220	ETR06E220	22	C, G, J, K, M	50
ET06E240	ETR06E240	24	C, G, J, K, M	50
ET06E270	ETR06E270	27	F, G, J, K, M	50
ET06E300	ETR06E300	30	F, G, J, K, M	50
ET06E330	ETR06E330	33	F, G, J, K, M	50
ET06E360	ETR06E360	36	F, G, J, K, M	50
ET06E390	ETR06E390	39	F, G, J, K, M	50
ET06E430	ETR06E430	43	F, G, J, K, M	50
ET06E470	ETR06E470	47	F, G, J, K, M	50
ET06E510	ETR06E510	51	F, G, J, K, M	50
ET06E560	ETR06E560	56	F, G, J, K, M	50
ET06E620	ETR06E620	62	F, G, J, K, M	50
ET06E680	ETR06E680	68	F, G, J, K, M	50
ET06E750	ETR06E750	75	F, G, J, K, M	50
ET06E820	ETR06E820	82	F, G, J, K, M	50

ET Part No.	ETR Part No.	Cap (pF)	Tolerances Available Voltage	DC Working
ET06, ETR06 (cont'd)				
ET06E910	ETR06E910	91	F, G, J, K, M	50
ET06E101	ETR06E101	100	F, G, J, K, M	50
ET06E111	ETR06E111	110	F, G, J, K, M	50
ET06E121	ETR06E121	120	F, G, J, K, M	50
ET06E131	ETR06E131	130	F, G, J, K, M	50
ET06E151	ETR06E151	150	F, G, J, K, M	50
ET06E161	ETR06E161	160	F, G, J, K, M	50
ET06E181	ETR06E181	180	F, G, J, K, M	50
ET06E201	ETR06E201	200	F, G, J, K, M	50
ET06E221	ETR06E221	220	F, G, J, K, M	50
ET06E241	ETR06E241	240	F, G, J, K, M	50
ET06E271	ETR06E271	270	F, G, J, K, M	50
ET06E301	ETR06E301	300	F, G, J, K, M	50
ET06E331	ETR06E331	330	F, G, J, K, M	50
ET06E361	ETR06E361	360	F, G, J, K, M	50
ET06E391	ETR06E391	390	F, G, J, K, M	50
ET06E431	ETR06E431	430	F, G, J, K, M	50
ET06E471	ETR06E471	470	F, G, J, K, M	50
ET06E511	ETR06E511	510	F, G, J, K, M	50
ET06E561	ETR06E561	560	F, G, J, K, M	50
ET07, ETR07				
ET07E621*	ETR07E621**	620	F, G, J, K, M	50
ET07E681	ETR07E681	680	F, G, J, K, M	50
ET07E751	ETR07E751	750	F, G, J, K, M	50
ET07E821	ETR07E821	820	F, G, J, K, M	50
ET07E911	ETR07E911	910	F, G, J, K, M	50
ET07E102	ETR07E102	1000	F, G, J, K, M	50
ET08, ETR08				
ET08E112*	ETR08E112**	1100	F, G, J, K, M	50
ET08E122	ETR08E122	1200	F, G, J, K, M	50
ET08E132	ETR08E132	1300	F, G, J, K, M	50
ET08E152	ETR08E152	1500	F, G, J, K, M	50
ET08E162	ETR08E162	1600	F, G, J, K, M	50
ET08E182	ETR08E182	1800	F, G, J, K, M	50
ET08E202	ETR08E202	2000	F, G, J, K, M	50
ET08E222	ETR08E222	2200	F, G, J, K, M	50
ET08E242	ETR08E242	2400	F, G, J, K, M	50

Add letter for tolerance code above lines.

These capacitors include a "burn in", see page 22 High Voltage Stabilization Screening.

Add letter for tolerance code above lines.

These capacitors include a "burn in", see page 22 High Voltage Stabilization Screening.

Dissipation Factor vs. Temperature

Radial

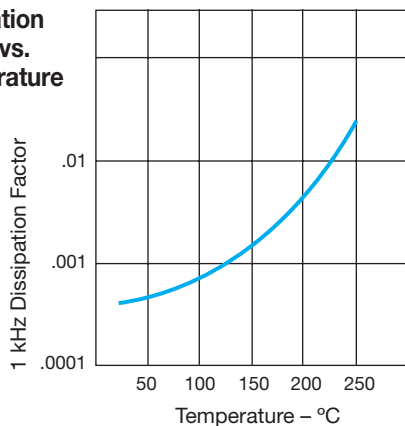

% Capacitance Change vs. Temperature

Radial

