



**LOW OHM
POWER RESISTORS**

**HTE
SERIES
Size 2512 / 1206**

- Open frame electron beam welded punched out type.
 - Power Rating at 100°C - upto 3W
 - Power Rating at 70°C - upto 6W
- R0003 to R01

As per AEC-Q200

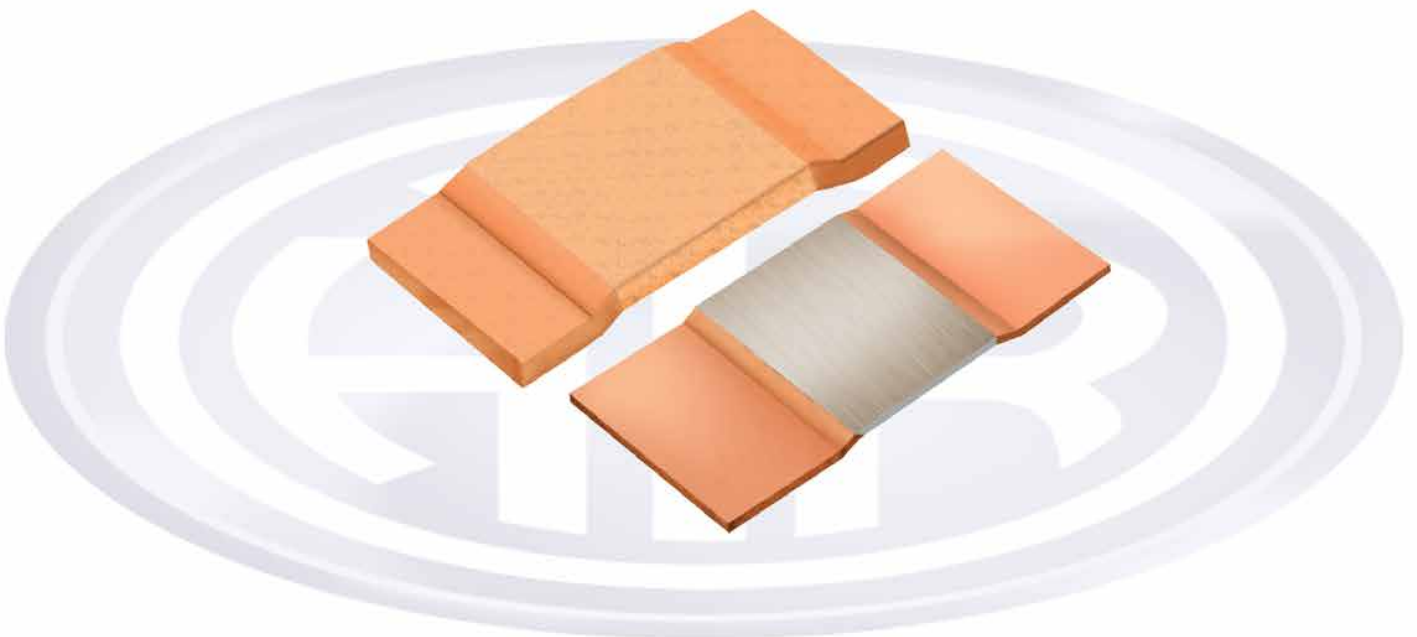



LOW OHM
POWER
RESISTORS
HTE
SERIES
Size 2512/ 1206

PHYSICAL CONFIGURATION

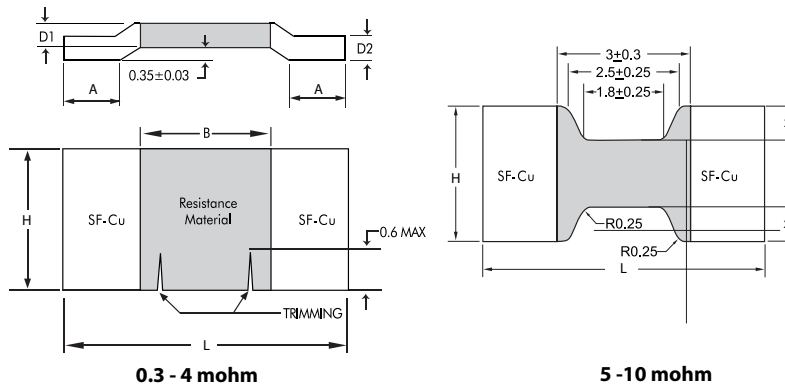

DIMENSION TABLE

'x' dimension will vary depending on resistance value

SR NO.	HI-TECH PART NAME	WATTAGE AT 100°C	WATTAGE AT 70°C	H	L	A	B (MM)	D1 (MM)	D2 (MM)	INTERNAL HEAT RESISTANCE (Rthi)	TCR (ppm)	TYPICAL WT. PER PC. (Gms)
1	HTE3W* R0003 F	3W	6W	3.1 ± 0.20	6.35 ± 0.15	1.14+0.0-0.4	3 ± 0.3	0.95 ± 0.10	0.95 ± 0.10	4°K/W	< 175	0.16
2	HTE3W* R0005 F	3W	6W	3.1 ± 0.20	6.35 ± 0.15	1.14+0.0-0.4	3 ± 0.3	0.85 ± 0.10	0.85 ± 0.10	7°K/W	< 115	0.14
3	HTE3W* R001 F	3W	5W	3.1 ± 0.20	6.35 ± 0.15	1.14+0.0-0.4	3 ± 0.3	0.42 ± 0.10	0.42 ± 0.10	14°K/W	< 100	0.07
4	HTE3W* R0013 F	3W	5W	3.1 ± 0.20	6.35 ± 0.15	1.14+0.0-0.4	3 ± 0.3	0.33 ± 0.10	0.33 ± 0.10	16°K/W	< 100	0.06
5	HTE3W* R002 F	3W	5W	3.1 ± 0.20	6.35 ± 0.15	1.14+0.0-0.4	3 ± 0.3	0.67 ± 0.10	0.67 ± 0.10	20°K/W	< 50	0.11
6	HTE2W* R003 F	2W	4W	3.1 ± 0.20	6.35 ± 0.15	1.14+0.0-0.4	3 ± 0.3	0.45 ± 0.10	0.45 ± 0.10	30°K/W	< 50	0.08
7	HTE2W* R004 F	2W	3W	3.1 ± 0.20	6.35 ± 0.15	1.14+0.0-0.4	3 ± 0.3	0.33 ± 0.10	0.33 ± 0.10	40°K/W	< 50	0.08
8	HTE1.5W* R005F	1.5W	2.5W	3.1 ± 0.20	6.35 ± 0.15	1.14+0.0-0.4	3 ± 0.3	0.33 ± 0.10	0.33 ± 0.10	50°K/W	< 50	0.08
9	HTE1.5W* R0068 F	1.5W	2W	3.1 ± 0.20	6.35 ± 0.15	1.14+0.0-0.4	3 ± 0.3	0.33 ± 0.10	0.33 ± 0.10	60°K/W	< 50	0.07
10	HTE1W* R01 F	1W	2W	3.1 ± 0.20	6.35 ± 0.15	1.14+0.0-0.4	3 ± 0.3	0.33 ± 0.10	0.33 ± 0.10	70°K/W	< 50	0.07
11	HTE* R000	I _{max} = 100A		3.1 ± 0.20	6.35 ± 0.15	1.14+0.0-0.4	0.42mm copper					0.07
12	HTE2W* R0003 F (1206)	2W	3.5W	1.65 ± 0.20	3.2 ± 0.20	0.80 ± 0.20	1.6+0.3	1.12 ± 0.15	1.12 ± 0.15		< 150	

APPLICATIONS

- Sensor of current for power hybrid applications.
- Automotive sector for high current applications.
- Frequency converters / Power modules.

FEATURES

- Ideal for mounting on DCB / IMS substrates.
- High temperature application due to nature of design.
- Excellent long term stability

PARAMETER / PERFORMANCE TEST & TEST METHOD	PERFORMANCE REQUIREMENTS
Power Rating	For FeCrAl - Full power dissipation at 70° C and linearly derated to zero at +170° C. For Manganin (< 0.5% Improved Stability) - Full power dissipation at 120° C & linearly derated to zero at +140° C. For Manganin (< 1% Stability) - Full power dissipation at 150° C and linearly derated to zero at +170° C.
Inductance	< 2nH
Resistance Tolerance	± 1% (0.5% and other tolerance available on request)
Temperature Range	- 55° C to +170° C (Suitably derated as per derating curve provided)
Voltage Rating / Limiting Voltage / Max. Working Voltage (Subject to max. Terminal Temperature of 120° C)	$\sqrt{P \times R}$
Low Temperature Storage and Operation [-65° C for 24 h]	$\Delta R \pm 0.1\%$ - Average
Temperature Coefficient of Resistance (Ambient Temperature Range 20° C - 60° C)	From 50 ppm (Depending on Resistance Value)
Temperature Cycling -2000 cycles (-55° C to 150° C)	$\Delta R \pm 0.5\%$ - Average
Life Test / Operational Life - 2000 h rated power with Temperature limitation on Terminal kept at 120° C	$\Delta R \pm 1\%$ - Average
Moisture Resistance [MIL-STD-202 method106]	$\Delta R \pm 0.2\%$ - Average
Mechanical Shock [100 g. 6 ms half sine]	$\Delta R \pm 0.2\%$ - Typical
Vibration, High Frequency [20 g. 10-2000 Hz]	$\Delta R \pm 0.2\%$ - Typical
Bias Humidity [+85° C, 85% RH, 1000h]	$\Delta R \pm 0.5\%$ - Typical



**LOW OHM
POWER
RESISTORS
HTE
SERIES
Size 2512/ 1206**

RECOMMENDED SOLDER PROFILE

Reflow and IR Soldering			
Temperature (°C)	260	255	217
Time (Sec)	Peak	40	90

RECOMMENDED PCB - LAYOUT

Recommended PCB layout for high precision applications

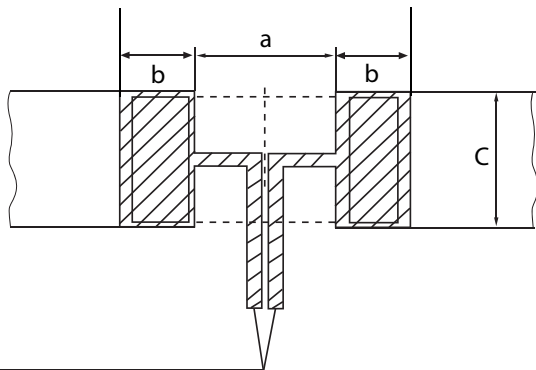

Sense Terminals

Recommended PCB layout for normal application

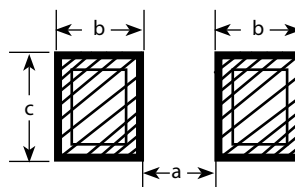

Size	a	b	c
1206	1.40	2.10	1.80
2512	3.4	1.8	3.4

PACKAGING

A. BULK

Resistors shall be packed in sealed plastic packets with silica gel pouch placed in small cardboard cartons (Type 'I' Box) of approximate size 70mmx70mmx70mm - 2500pcs. & such 4 Boxes packed in (Type 'A' Box) of approximate size 200mmx150mmx70mm & 8 Boxes in (Type 'B' Box) of approximate size 295mmx140mmx80mm. & such 36 Boxes of Type 'I' or 6 Boxes of Type 'A' packed in Master Carton of approximate size 320mmx245mmx245mm.

B. TAPE & REEL PACKING

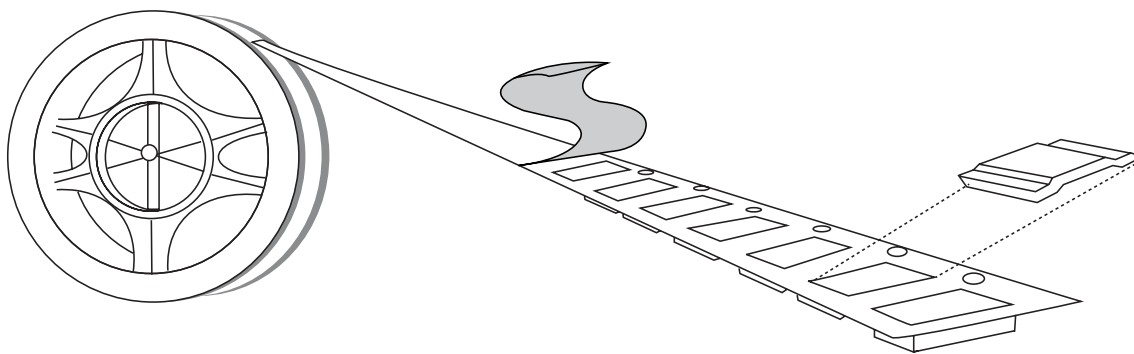

SPECIFICATION	SIZE	TAPEWIDTH	PARTS PER REEL
EIA-481-D	2512	12mm	3000 pcs
	1206	8mm	3000 pcs

Storage Condition (Packed) : Temp 25°C to 35°C, Humidity 30 to 80% RH, Shelf life-12 months

Floor Life (Unpacked) : Temp 25°C to 35°C, Humidity 30 to 80% RH, Floor life-15 days

ORDERING INFORMATION

SERIES	TYPE	PACKING	RESISTANCE VALUE	TOLERANCE
HTE	HTE3W / HTE3W*	Bulk - HTE3W / HTE3W* Tape & Reel - HTE3WTR / HTE3W*TR	R001	F

TYPICAL POWER DERATING CURVE FOR RESISTOR WHEN FULL POWER IS AT 120°C & 150°C

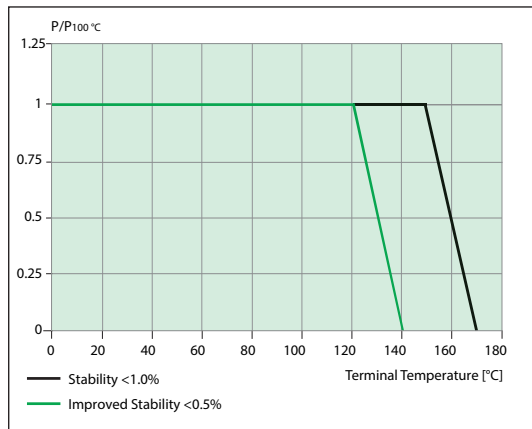

TYPICAL POWER DERATING CURVE FOR RESISTOR WHEN FULL POWER IS AT 70°C

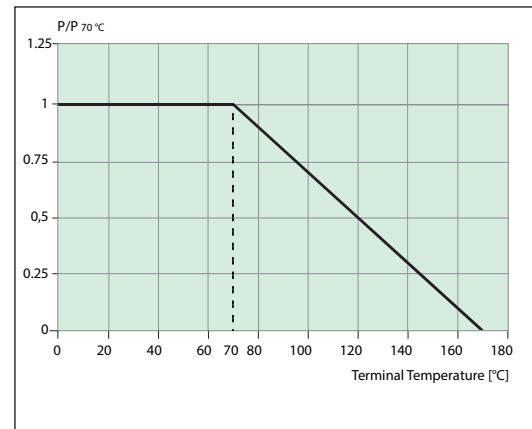

In case the Design Engineer requires a specific graph of a particular component it can be supplied on request.

MAXIMUM PULSE ENERGY WITH RESPECT TO PULSE POWER FOR PERMANANT OPERATION

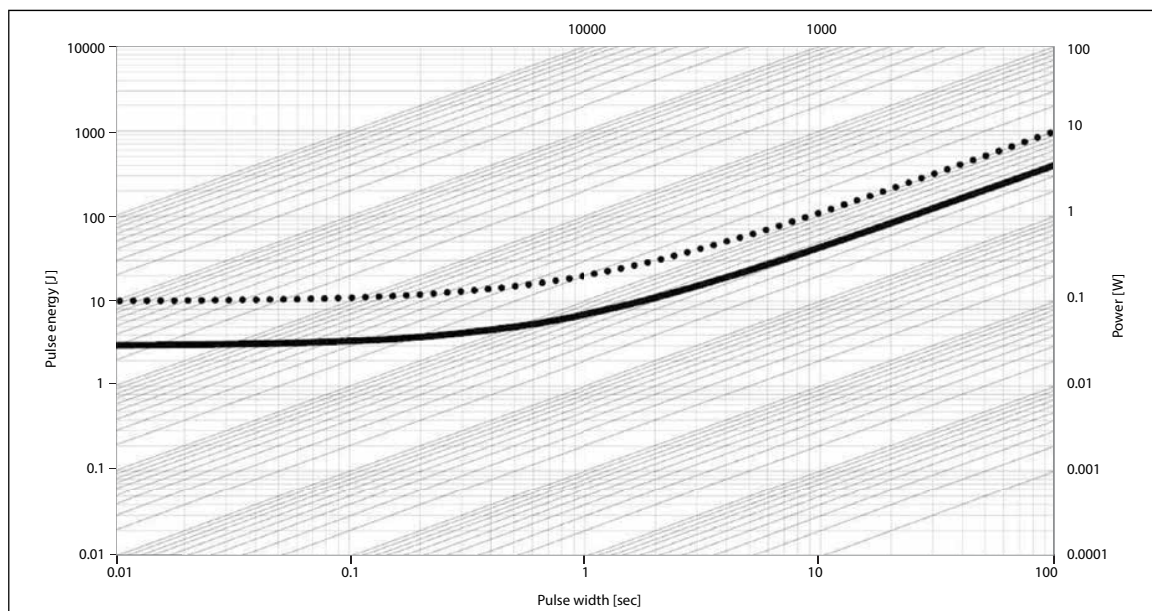

In this graph the max. & min. curve are shown as ●●● and — for all resistance values, the area between the max. & min. curve is applicable. In case the Design Engineer requires a specific graph of a particular component it can be supplied on request.

TYPICAL TEMPERATURE DEPENDANCE OF THE ELECTRICAL RESISTANCE

